

SDM100

1 to 8 sections
monoblock valve

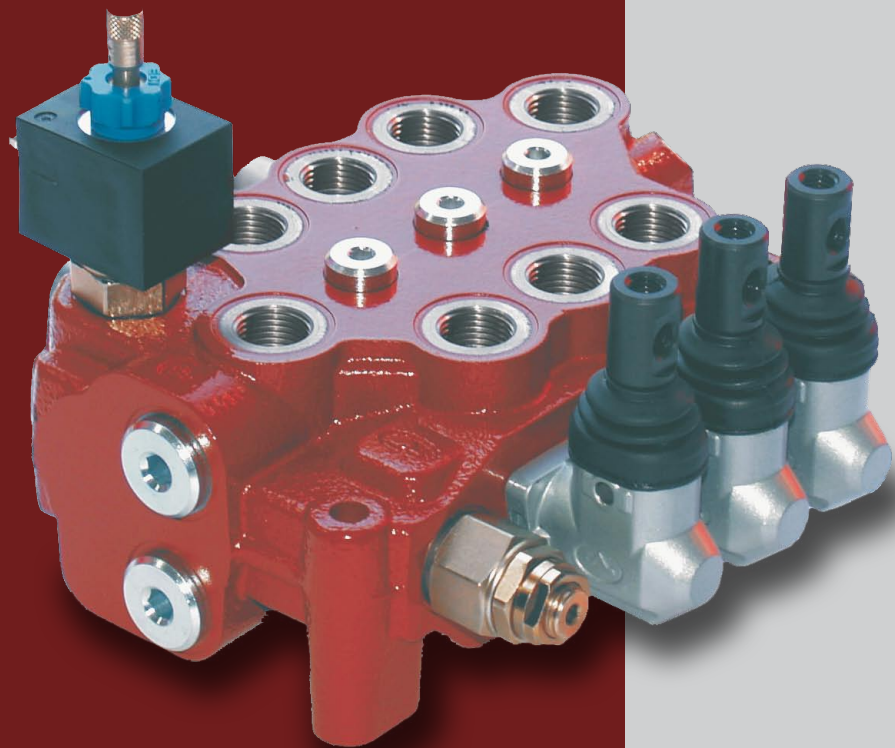

Additional information

This folder shows the product in the most standard configurations. Please contact Sales Dpt. for more detailed information or special request.

WARNING!

All specifications of this folder refer to the standard product at this date. Walvoil, oriented to a continuous improvement, reserves the right to discontinue, modify or revise the specifications, without notice.

WALVOIL IS NOT RESPONSIBLE FOR ANY DAMAGE CAUSED BY AN INCORRECT USE OF THE PRODUCT.

Features

- Fitted with a main pressure relief valve and a load check valve on every working section.
- Available with parallel and series circuit, one section with series-parallel (tandem) circuit on request.
- Optional power beyond port.
- Anticavitation and antishock valves (with fixed or adjustable setting) available on every section.
- Optional flange mounted pilot check valves on every sections.
- Optional unloader solenoid valves.
- Wide range of controls: manual, pneumatic, electropneumatic, hydraulic, electrohydraulic, electric and remote with flexible cable.

Working conditions

This catalogue shows technical specifications and diagrams measured with mineral oil of 46mm²/s - 46 cSt viscosity at 40°C - 104°F temperature.

Nominal flow rating		70 l/min	18 US gpm
Operating pressure (max.)		315 bar	4600 psi
Back pressure (max.)	on outlet port T	10 bar	1450 psi
Internal leakage (max.) A(B)⇒T	Δp = 100 bar - 1450 psi fluid and valve at 40°C -104°F	5 cm ³ /min (max. 9 cm ³ /min)	0.31 in ³ /min (max. 0.55 in ³ /min)
Fluid		Mineral based oil	
Fluid temperature	with NBR (BUNA-N) seals	from -20°C to 80°C	from -4°F to 176°F
	with FPM (VITON) seals	from -20°C to 100°C	from -4°F to 212°F
Viscosity	operating range	from 15 to 75 mm ² /s	from 15 to 75 cSt
	min.	12 mm ² /s	12 cSt
	max.	400 mm ² /s	400 cSt
Max contamination level		-/19/16 - ISO 4406	NAS 1638 - class 10
Ambient temperature for working conditions	with mechanical devices	from -40°C to 60°C	from -40°F to 140°F
	with pneumatic and hydraulic devices	from -30°C to 60°C	from -22°F to 140°F
	with electric devices	from -20°C to 50°C	from -4°F to 122°F

NOTE - for different conditions please contact Sales Dpt

Standard threads

REFERENCE STANDARD					
		BSP	UN-UNF	METRIC	NPTF
THREAD ACCORDING TO		ISO 228/1	ISO 263	ISO 262	ANSI B1.20.3
		BS 2779	ANSI B1.1 unified		
CAVITY DIMENSION ACCORDING TO	ISO	1179	11926	6149	
	SAE		J1926	J2244	J476a
	DIN	3852-2 shape X or Y			

PORTS			
	BSP	UN-UNF	METRIC
Inlet P and power beyond C	G 1/2	7/8-14 (SAE10)	M22x1.5
Ports A and B	G 3/8	3/4-16 (SAE8)	M18x1.5
Outlet T	G 1/2	7/8-14 (SAE10)	M22x1.5
Hydraulic pilot	G 1/4	7/16-20 (SAE4)	G 1/4
Pneumatic pilot		NPTF 1/8-27	

NOTE- for different port size contact Sales Dpt

Performance data

General

P ⇒ T pressure drop*

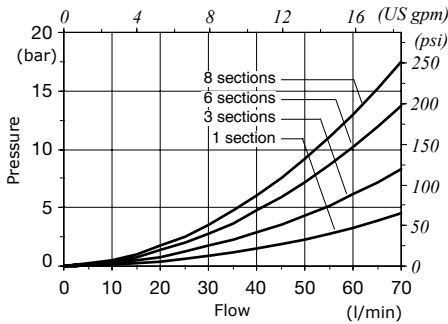

P ⇒ A(B) e A(B) ⇒ T pressure drop*

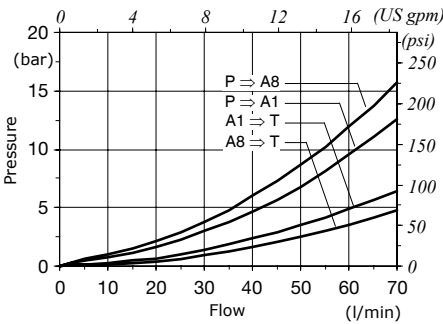

Spool type 1 P ⇒ A(B) metering curve

Q_{in} = depending on spool - P = 60 bar / 870 psi

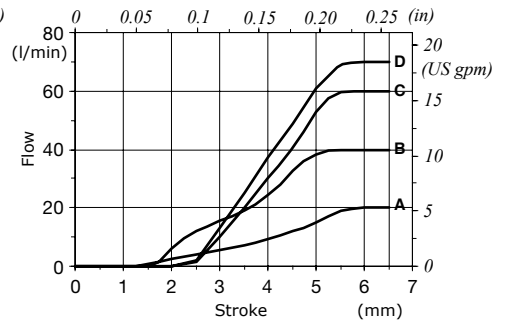

Note (*): pressure drop curve with spool type 109 (for up to 60 l/min - 16 US gpm flow)

- A = spool type 102, up to 20 l/min - 5.3 US gpm
- B = spool type 101, up to 40 l/min - 10.5 US gpm
- C = spool type 109, up to 60 l/min - 16 US gpm
- D = spool type 127, up to 70 l/min - 18.5 US gpm

Main pressure relief valve

TVG2 valve setting range (green band)

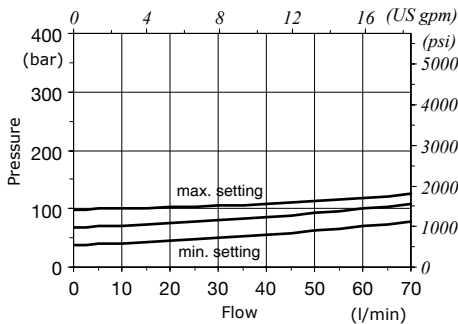

TVG3 valve setting range (blue band)

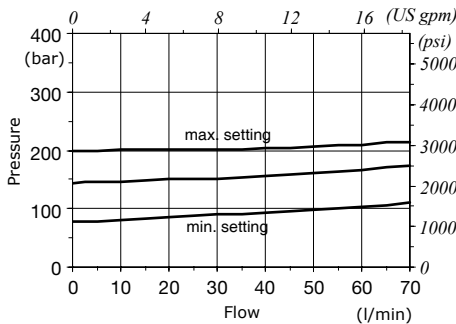

TVG4 valve setting range (red band)

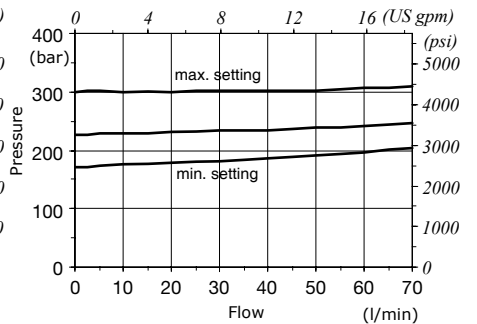

Auxiliary valves

Port valves type U

Setting examples (10 l/min - 2.6 US gpm)

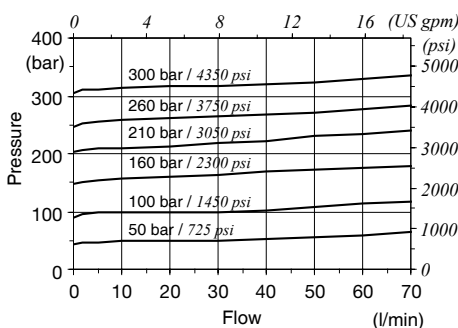

Type U valves pressure drop (in anticavitation)

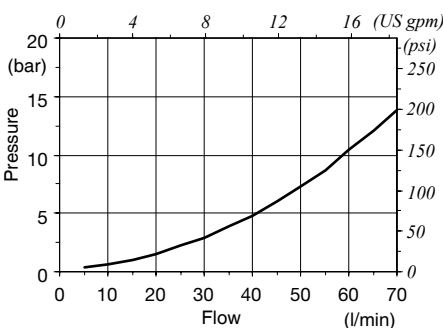

Unloader valve pressure drop

On SDM100/3 directional valve

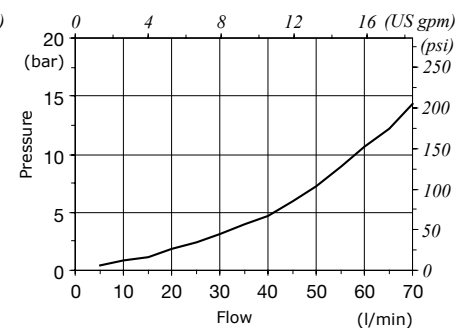

SDM100

Dimensional data

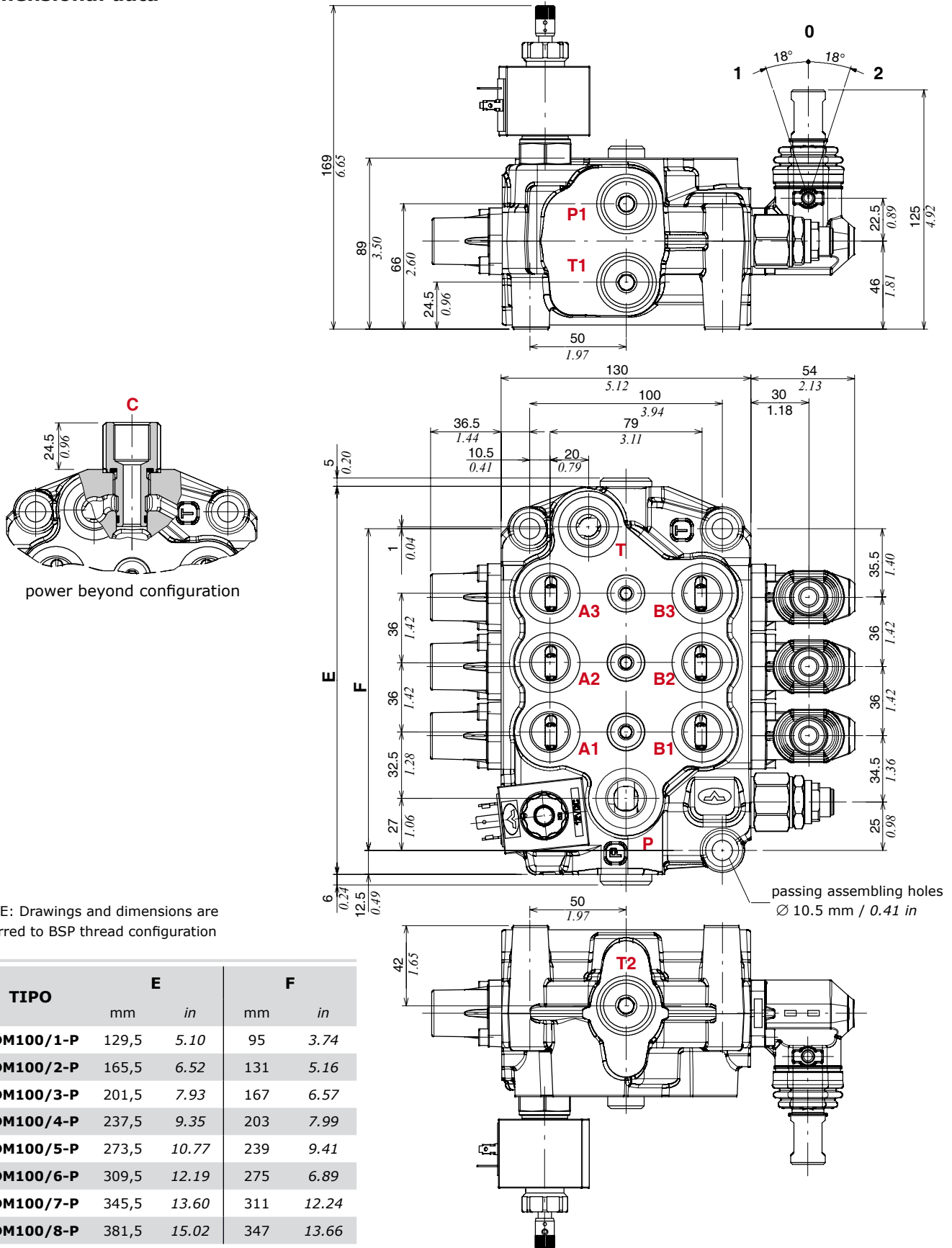

NOTE: Drawings and dimensions are referred to BSP thread configuration

TIPO	E		F	
	mm	in	mm	in
SDM100/1-P	129,5	5.10	95	3.74
SDM100/2-P	165,5	6.52	131	5.16
SDM100/3-P	201,5	7.93	167	6.57
SDM100/4-P	237,5	9.35	203	7.99
SDM100/5-P	273,5	10.77	239	9.41
SDM100/6-P	309,5	12.19	275	6.89
SDM100/7-P	345,5	13.60	311	12.24
SDM100/8-P	381,5	15.02	347	13.66

Hydraulic circuit

Parallel circuit configuration

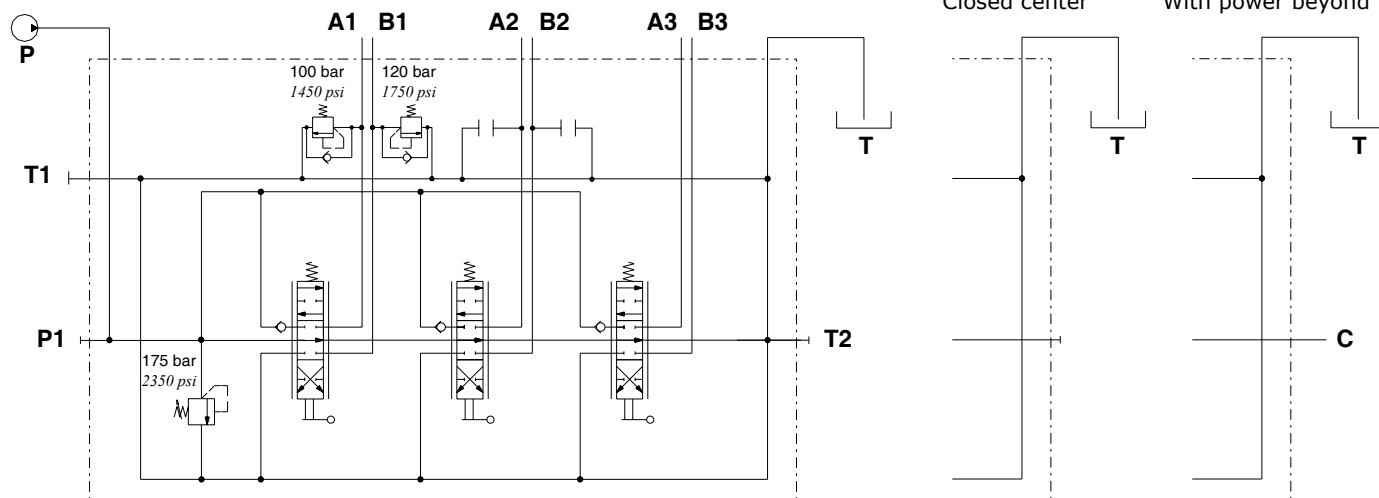

Series circuit configuration

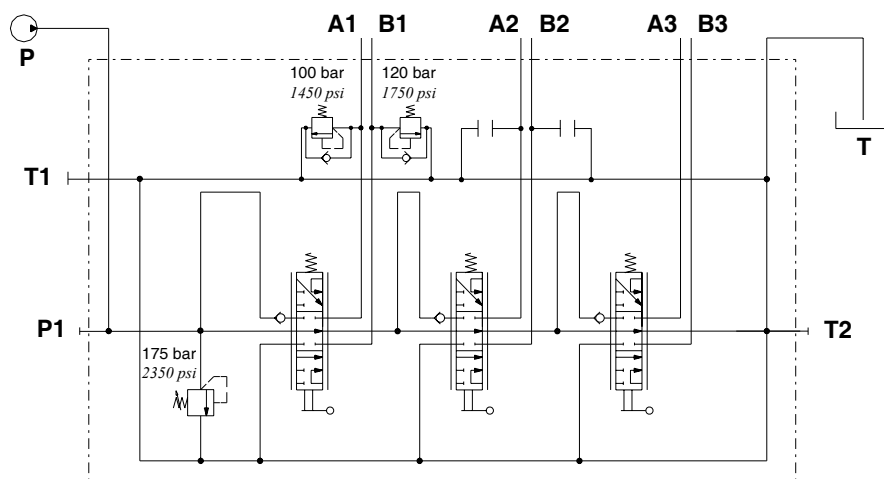

Series-parallel circuit (tandem) configuration

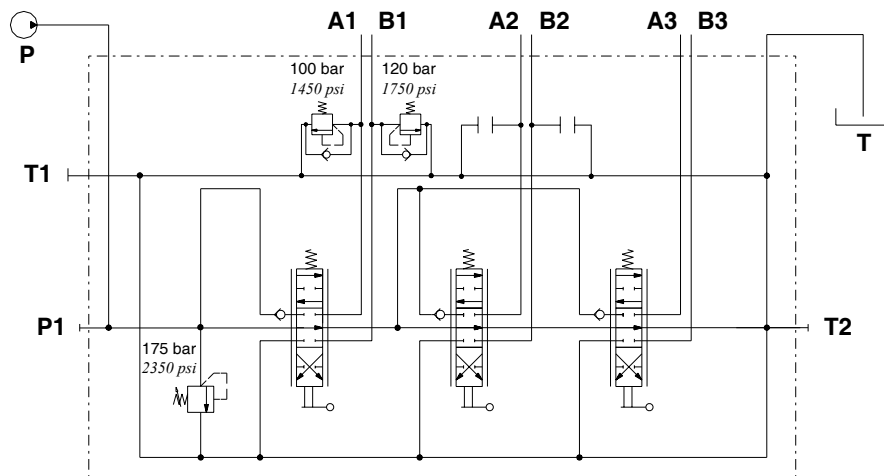

Description composition

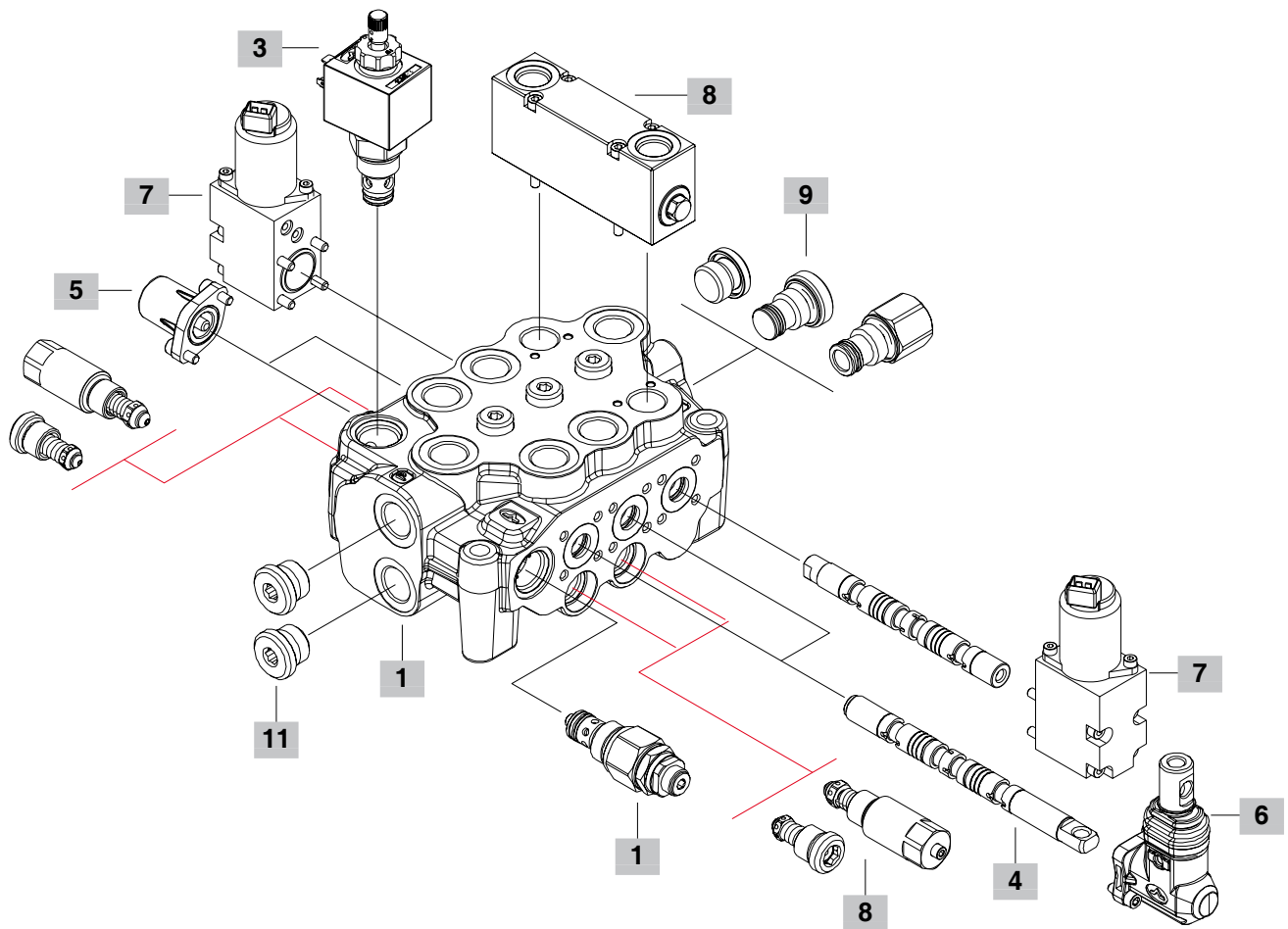
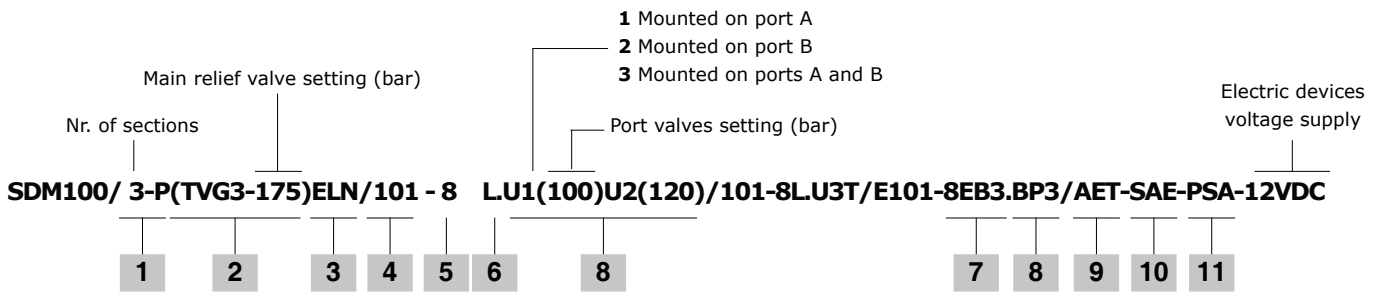

1 Body kit

- | | |
|-----------------------------|-----------------------------|
| 1-P: 1 section body | 5-P: 5 sections body |
| 2-P: 2 sections body | 6-P: 6 sections body |
| 3-P: 3 sections body | 7-P: 7 sections body |
| 4-P: 4 sections body | 8-P: 8 sections body |
- For series and series-parallel circuit contact Sales Department

2 Pressure relief valve

- Direct operation
- (TVG2-80):** Setting range from 63 to 100 bar / 900 to 1450 psi, standard setting 80 bar / 1160 psi
- (TVG3-175):** Setting range from 100 to 200 bar / 1450 to 2990 psi, standard setting 175 bar / 2550 psi
- (TVG4-220):** Setting range from 200 to 300 bar / 2900 to 4350 psi, standard setting 220 bar / 3200 psi
- SV:** Valve blenking plug

Description composition

3 Unloader valve

ELN: Solenoid operated without emergency push-button
ELP: Solenoid operated with emergency push-button
ELT: Solenoid operated with "push and twist" emergency push-button
LT: Valve blanking plug

4 Spools

If not specified otherwise, the spools are up to 40 l/min - 10.5 US gpm flow

102: Double acting, 3 positions, with A and B closed in neutral position; for up to 20 l/min - 5.3 US gpm flow
101: As previous, up to 40 l/min - 10.5 US gpm flow
109: As previous, up 60 l/min - 16 US gpm flow
127: As previous, up 70 l/min - 18.5 US gpm flow
201: Double acting, 3 positions, with A and B open to tank in neutral position
2H01: Double acting, 3 positions, with A and B partially open to tank in neutral position
1S02: Double acting, 3 positions, with A and B closed in neutral position, for series circuit
2S01: Double acting, 3 positions, with A and B closed in neutral position, for series circuit
301: Single acting in A, 3 positions, B plugged
401: Single acting in B, 3 positions, A plugged:
801: Double acting, 3 positions, regenerative in 2nd positions with spool out
501: Double acting, 4 positions, floating in 4th positions with spool in: for "A" side positioners type 13 and 13F. Need special body, contact Sales Department

5 "A" side spool positioners

7FTN: With friction and neutral position sensor
8: With spring return in neutral position
8D: As type 8 and pin with M6 female thread for dual control
8F2: With spring return in neutral position and adjustable flow limiter in position 2
8TL: As type 8 and pin control for flexible cable operation
9B: With detent in position 1 and spring return in neutral position
10B: With detent in position 2 and spring return in neutral position
11B: With detent in position 1 and 2, spring return in neutral position
8K: As type 8 with spool solenoid lock device
8RM2: With spring return in neutral position and electromagnetic detent in position 2
8MG3(NO): With spring return in neutral position and operation with microswitch in pos. 1 and 2
8PP: Proportional pneumatic kit
8EP3: ON/OFF electropneumatic kit
13: 4 positions, spring return in neutral, detent in 4th position: for spool type 501
13F: 4 positions with spring return in neutral: for spool type 501

6 "B" side options

L: Standard lever box
LF1: Lever box with adjustable flow limiter in position 1
LB3: Steel lever box, heavy duty type
SLP: Without lever box, with dust-proof plate
SLC: Without lever box, with endcap
LCA1-4: Joystick for 2 sections operation: config. type 1 and 4
LCA2-3: Joystick for 2 sections operation: config. type 2 and 3
SLK: Type SLP with solenoid spool lock device, needs special spools: contact Sales Department

7 Complete controls

They need special spools and particular bodies: contact Sales Dpt.

ON/OFF direct solenoid control

Note: The correct operation of the control, at the valve nominal pressure, is assured up to 50 l/min; please Contact the Sales Department for higher flow.

8ES1: Spring return to neutral, single acting in A
8ES2: Spring return to neutral, single acting in B
8ES3: Spring return to neutral, double acting
Double side proportional hydraulic control
8IM: Spring return to neutral
13IM: Spring return to neutral for floating circuit spool
Double side proportional electrohydraulic control
8EB3: Spring return to neutral
8EB3LH: With spring return to neutral and wet-type lever control
13EB3: As type 8EB3 for floating circuit spool
13EB3LH: As type 8EB3LH for floating circuit spool

8 Port valves

C: Anticavitation valve
P: Fixed setting antishock valve: for complete list contact Sales Dpt.
U: Fixed setting antishock with prefill valve: for list contact Sales Dpt.
UR: Adjustable setting antishock with prefill valve: for adjusting range contact Sales Department
UT: Valve blanking plug
BP: Flange mounted pilot check valves: assembled on ports side

9 Circuit options

AET: Open center
AEK: Closed center
AE: With power beyond sleeve
VRC: With backpressure valve
VRE: With backpressure valve and power beyond sleeve

10 Threading specification

Specify thread type only if is different from BSP standard: see page 4

11 Port selections

PSA: Upper inlet P and outlet T
PSL: Side inlet P1 and outlet T2
PSL-NOTAP(T1): Side inlet P1 and outlet T1, on each side

D1WWDA02A - 1st edition April 2009



WWW.WALVOIL.COM