

# Rotator CR 500

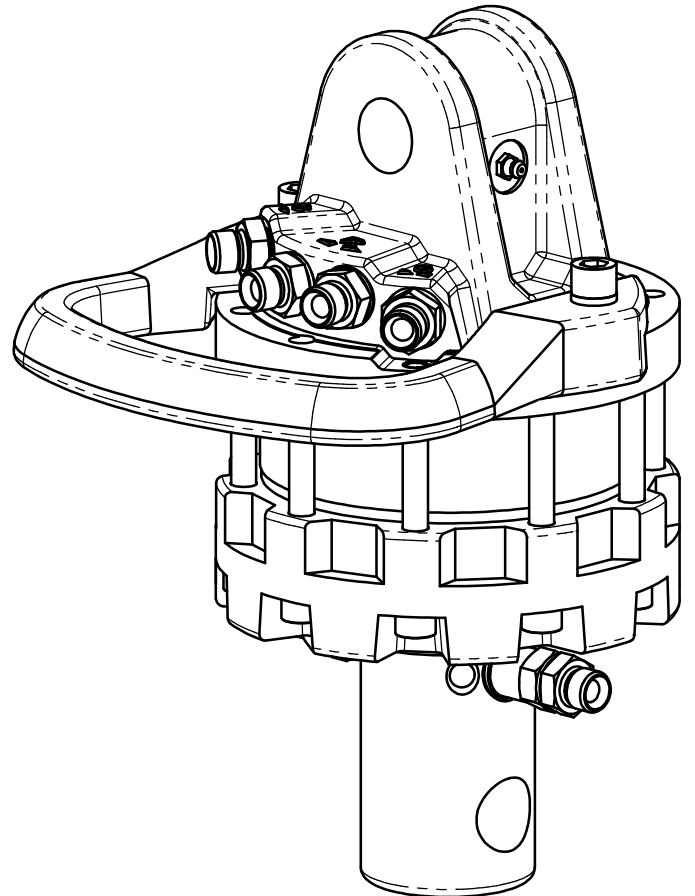
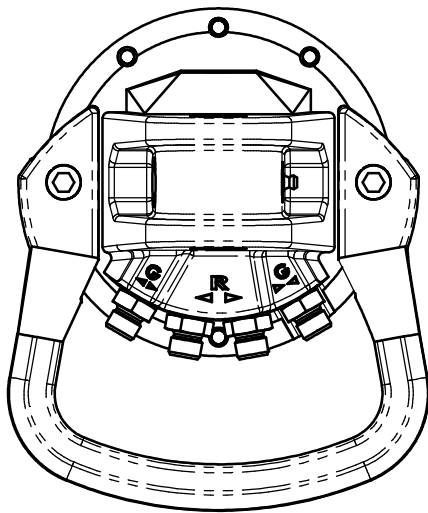
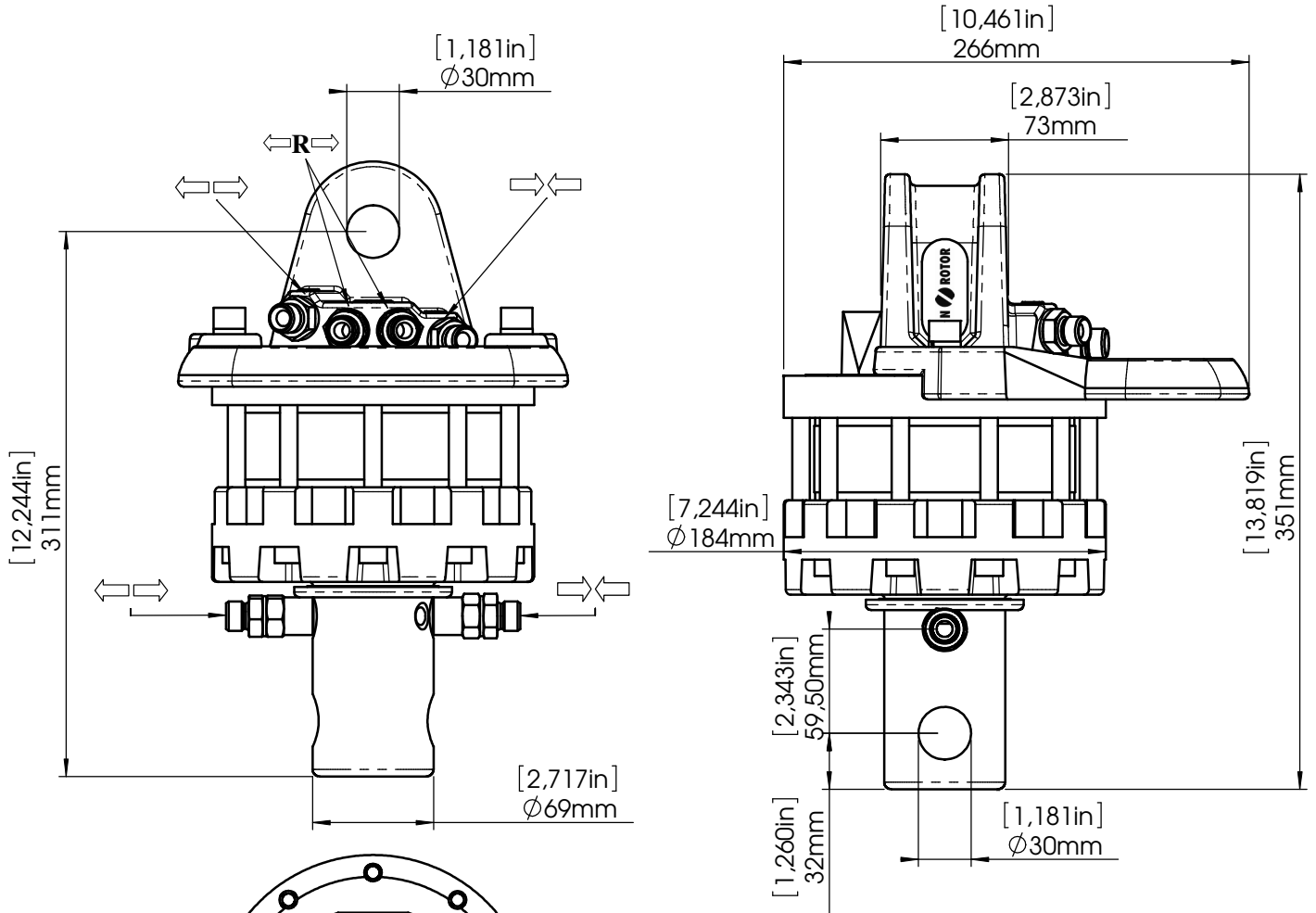

CR 500	
Rotation angle	Unlimited
Max. working pressure	250 bar
Displacement	465 cm <sup>3</sup>
Torque (250 bar)	1400 Nm
Max. axial load static kN	55 kN
Max. axial load dynamic kN	25 kN
Weight	28 kg