

# Rotator CR 400

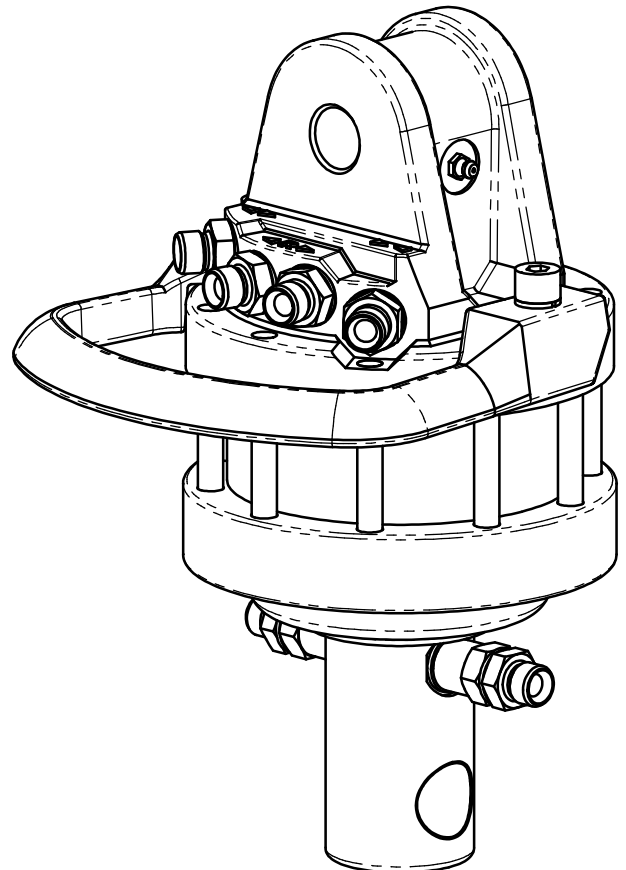
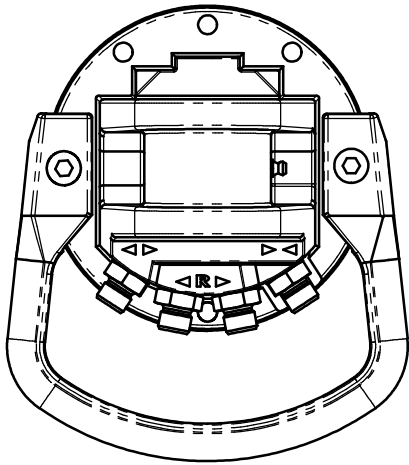
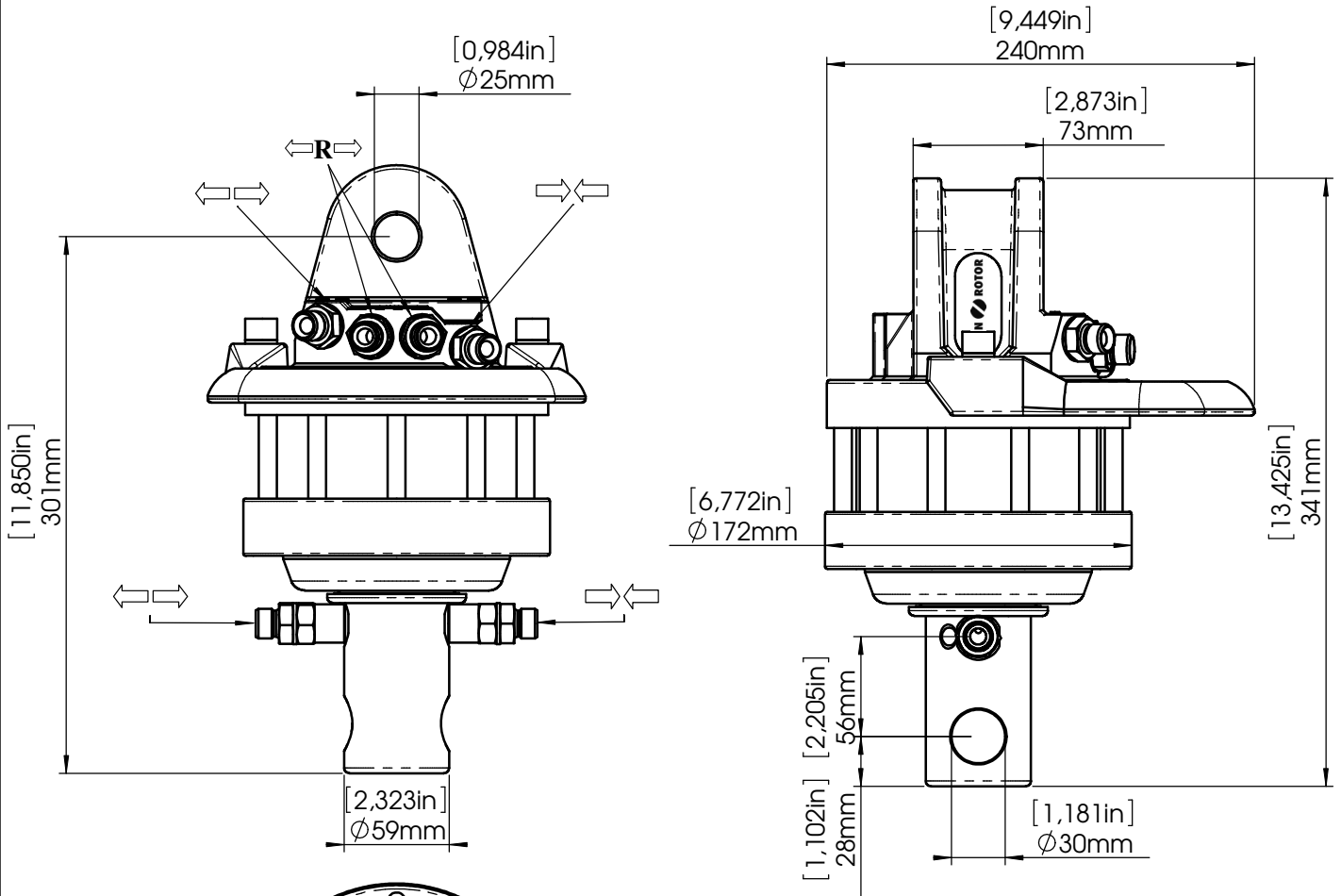

CR 400	
Rotation angle	Unlimited
Max. working pressure	250 bar
Displacement	420 cm <sup>3</sup>
Torque (250 bar)	1100 Nm
Max. axial load static kN	40 kN
Max. axial load dynamic kN	20 kN
Weight	23 kg