

Rotator CR 1000FW

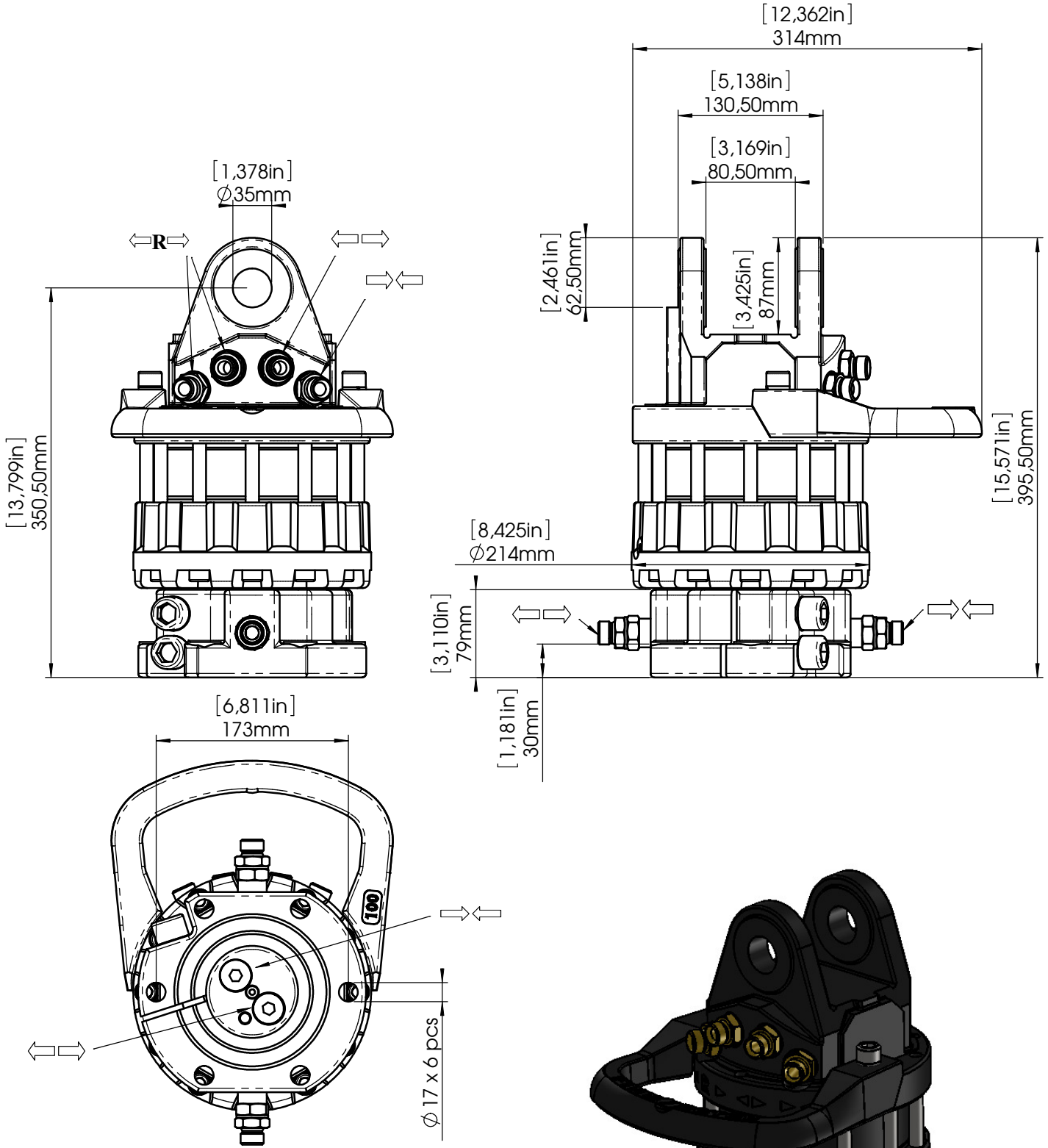

CR 1000FW	
Rotation angle	Unlimited
Max. working pressure (rotation)	250 bar
Max. working pressure (open line)	300 bar
Max working pressure (close line)	300 bar
Displacement	871 cm ³
Torque (250 bar)	2700 Nm
Max. axial load static kN	100/-80 kN
Max. axial load dynamic kN	50/-40 kN
Weight	64 kg
Connections	G1/2"